

1.

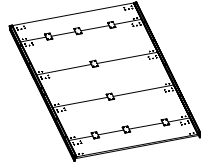

2.

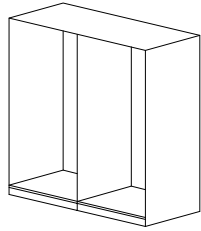

1.

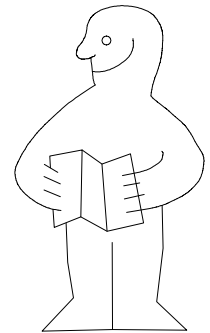
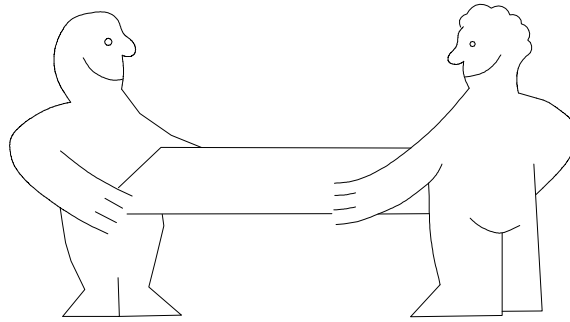
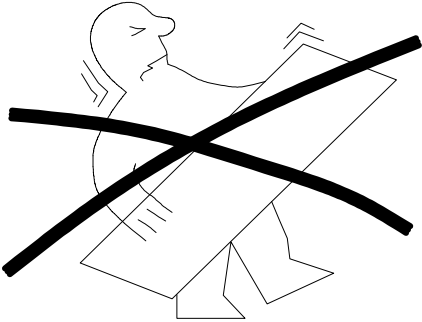
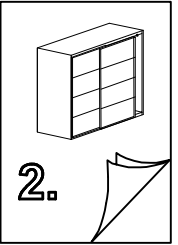
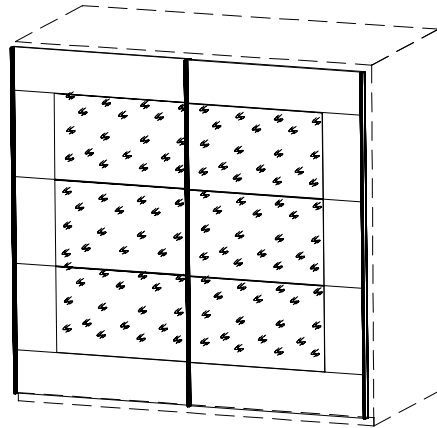

1-2-3-4... ○

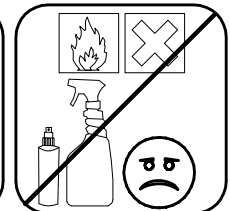
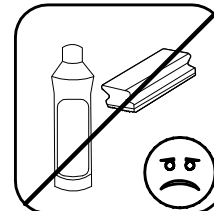
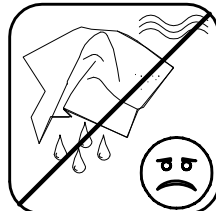
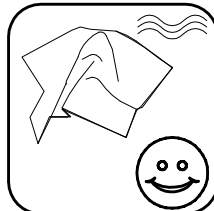
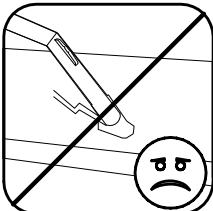
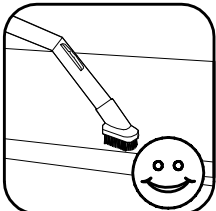
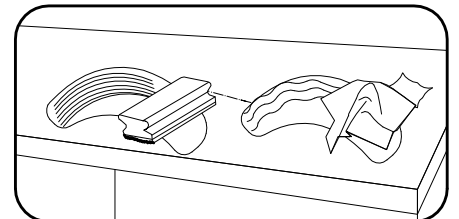
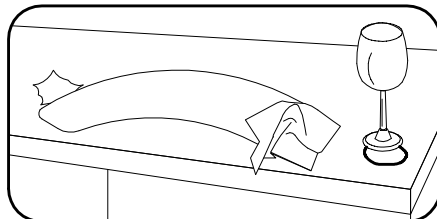
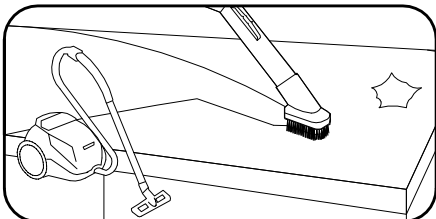
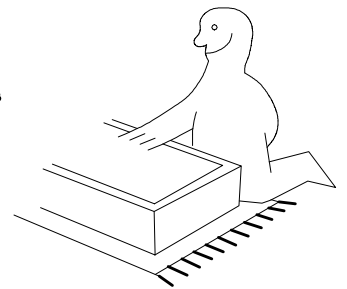
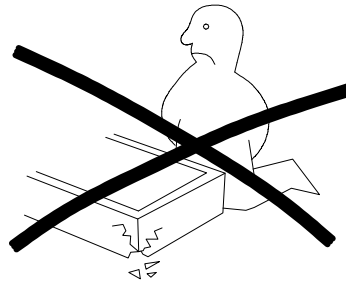
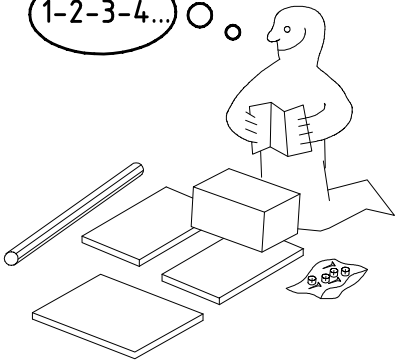

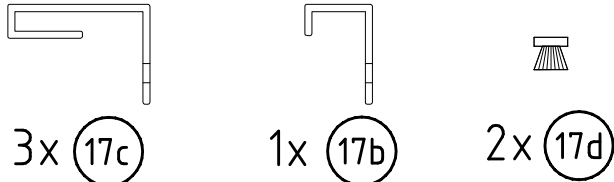
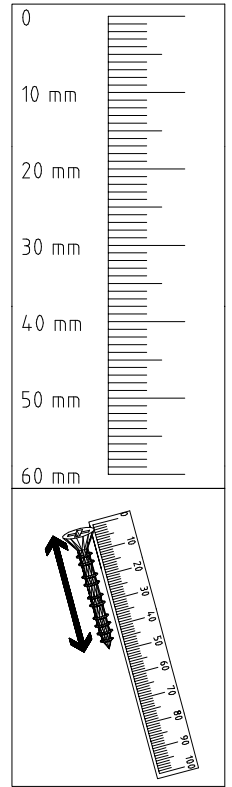
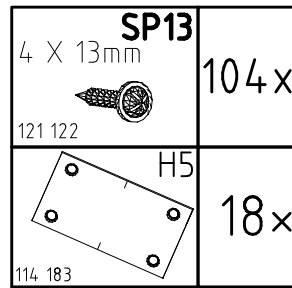
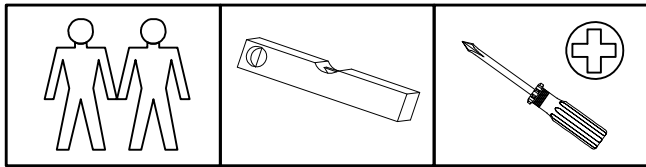

3x (17c)

1x (17b)

2x (17d)

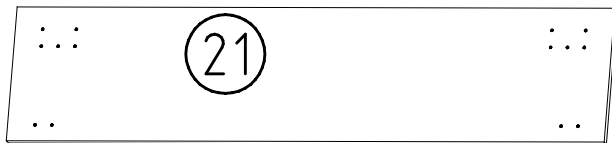
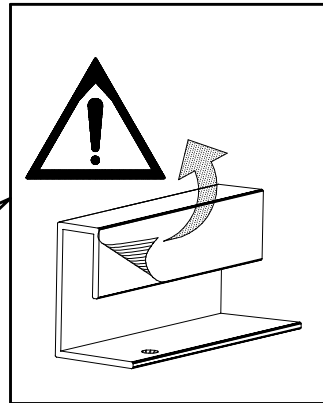
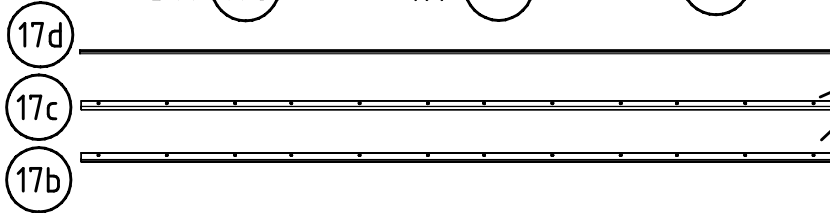

4x 695 / 916 / 1135 / 1357 / 1579 x 252 x 15

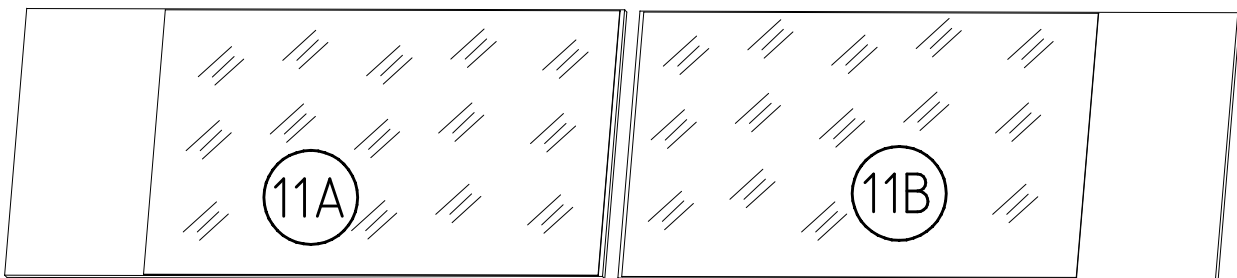

6x 695 / 916 / 1135 / 1357 / 1579 x 504 x 15 3x A / 3x B

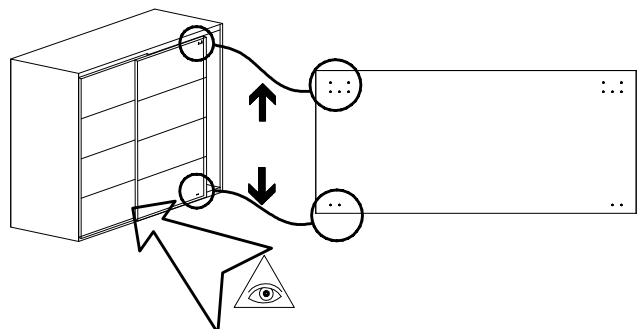
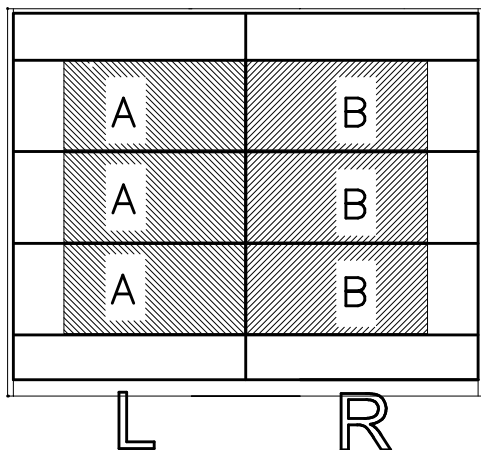

1

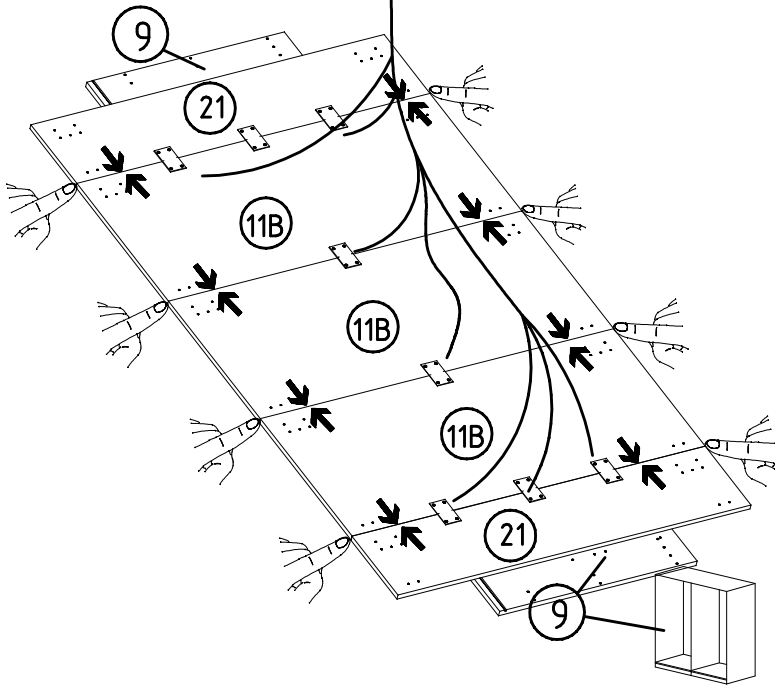
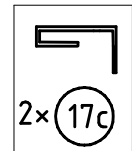
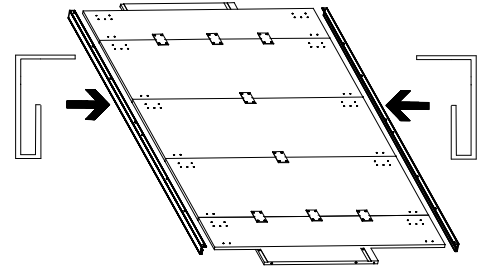
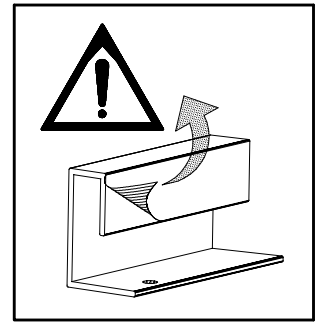
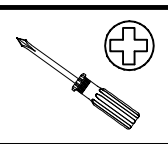
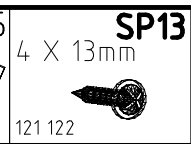
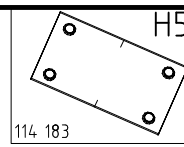
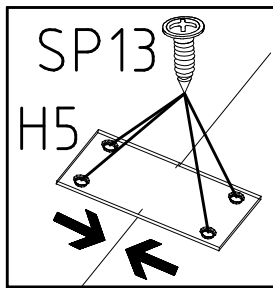
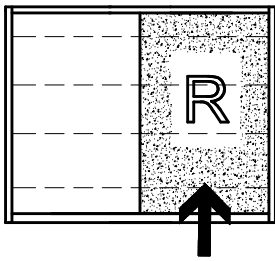

2

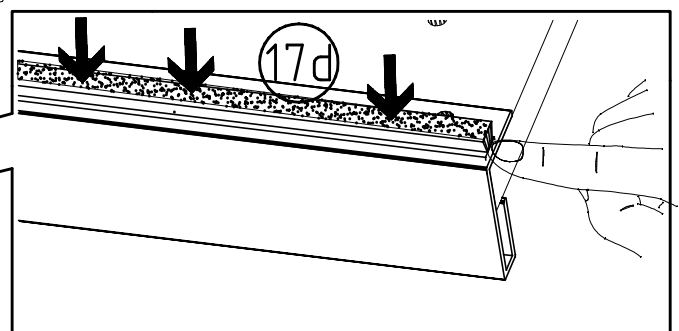
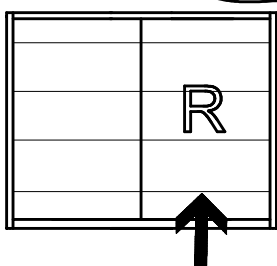
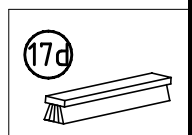
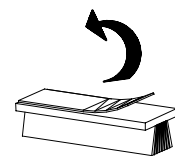
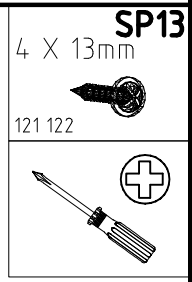
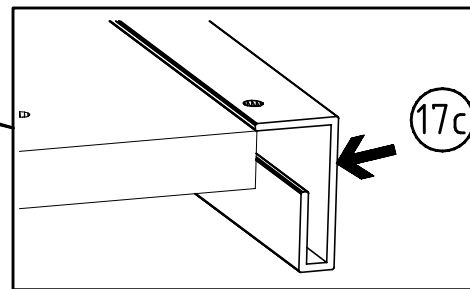
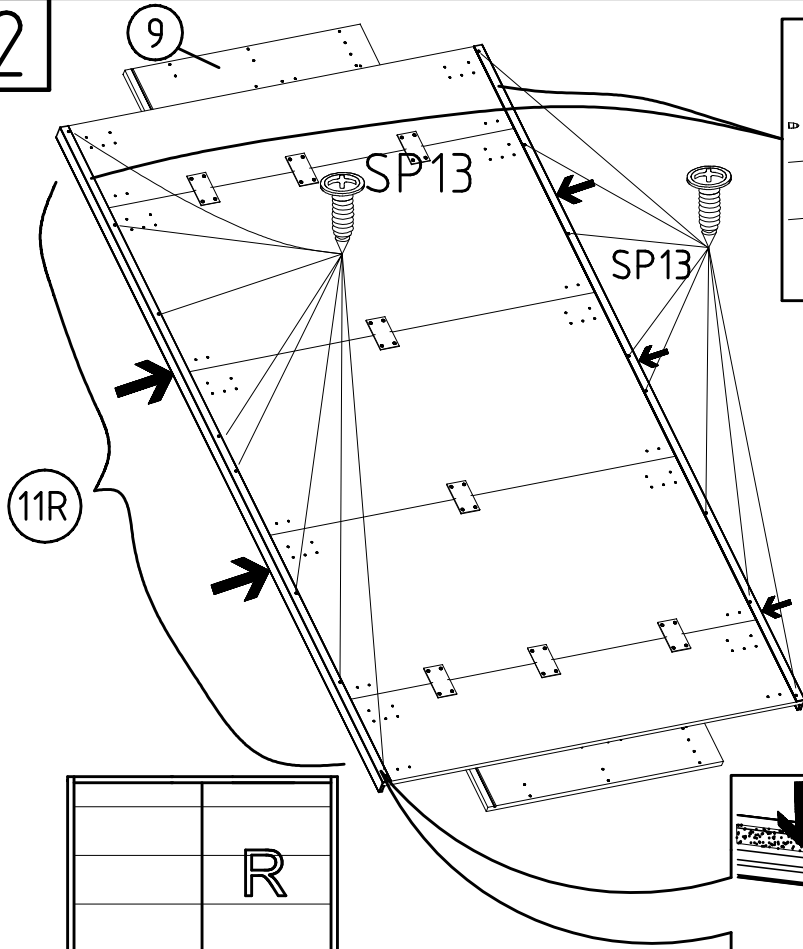

3

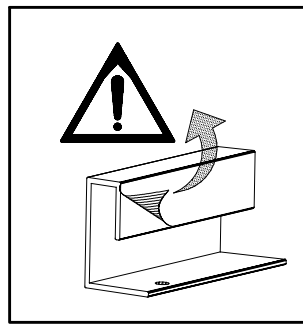
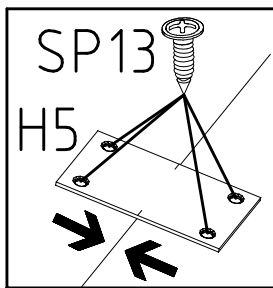
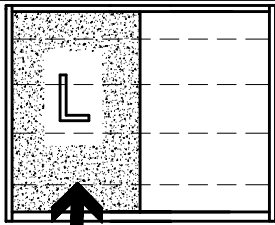

H5
4 X 13mm
114 183

SP13
121 122

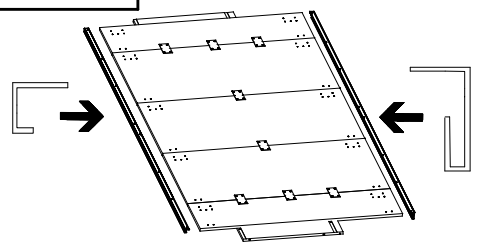
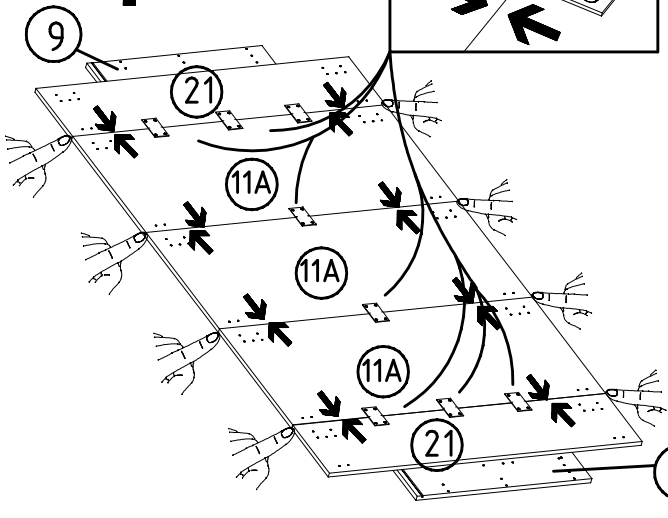

1x (17c)

1x (17b)

4

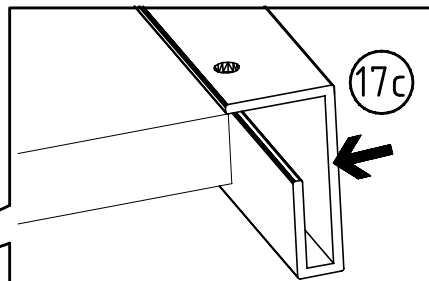
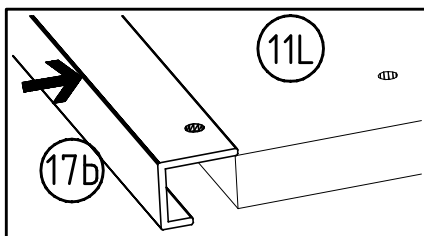

SP13
4 X 13mm
121 122

